







9

9

&



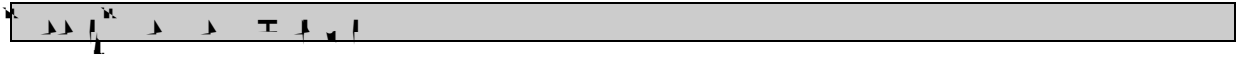

1. The first part of the document is a list of symbols and characters.



1



q

q

Y











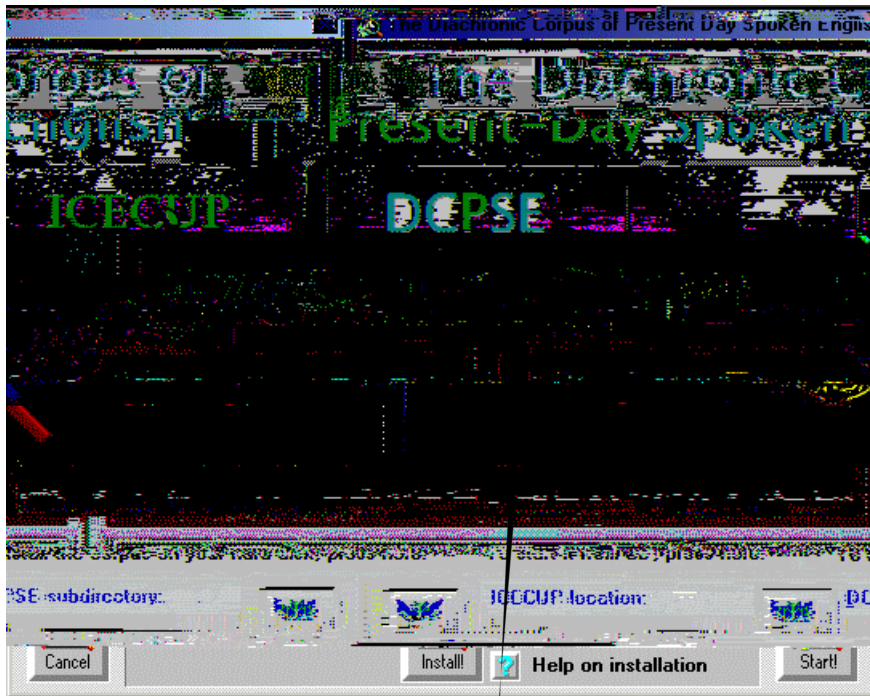

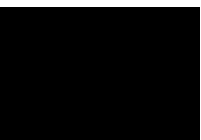





2

2

•

•



22

d

y



play	V(montr,infm)	it	DI-B14	0218	Even Meryl Streep could
play	V(montr,infm)	it back to anyone <,>	DI-B14	0237	She's not going to
Play	V(montr,infm)	it back to the → to th	DI-B14	0250	
play	V(montr,infm)	tennis	DI-B16	0221	Does she
play	V(montr,infm)		DI-B20	0009	what sort of music do they
play	N(com,sing)	at the uhm <> Royal C	DI-B20	0050	I went to see a new
play	V(montr,infm)	this	DI-B20	0216	So where d'you
play	V(utr,infm)		DI-B20	0221	So whe ... → how often do you
play	V(utr,ores)	uhm <,> once a week to	DI-B20	0222	I











▶

▶

▶

y

▶



d

•







5. 

22





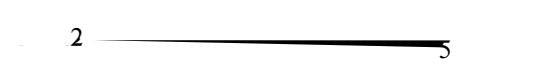
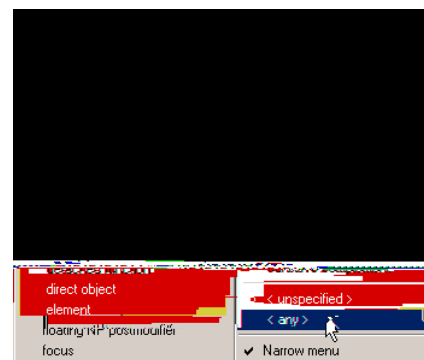
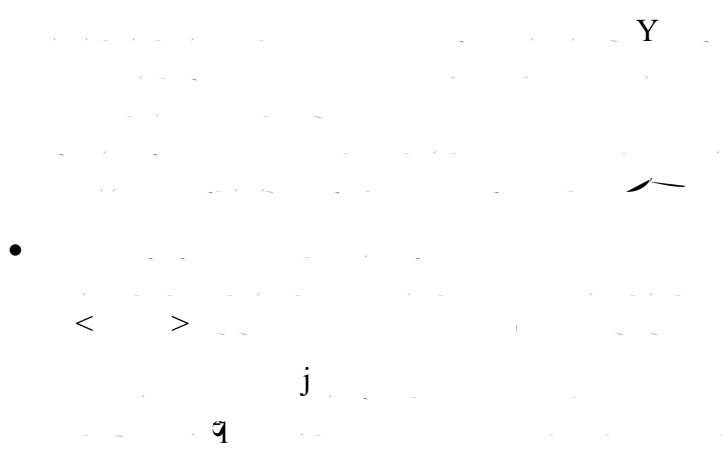
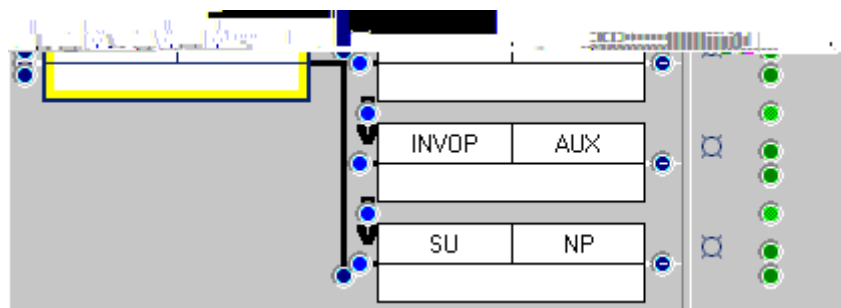
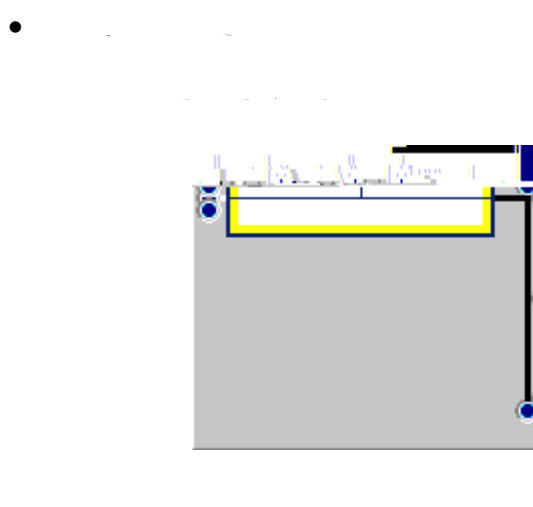
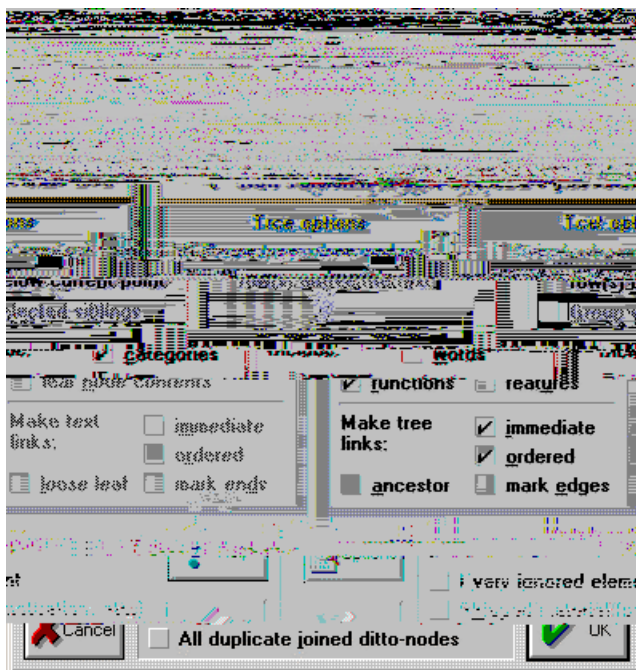
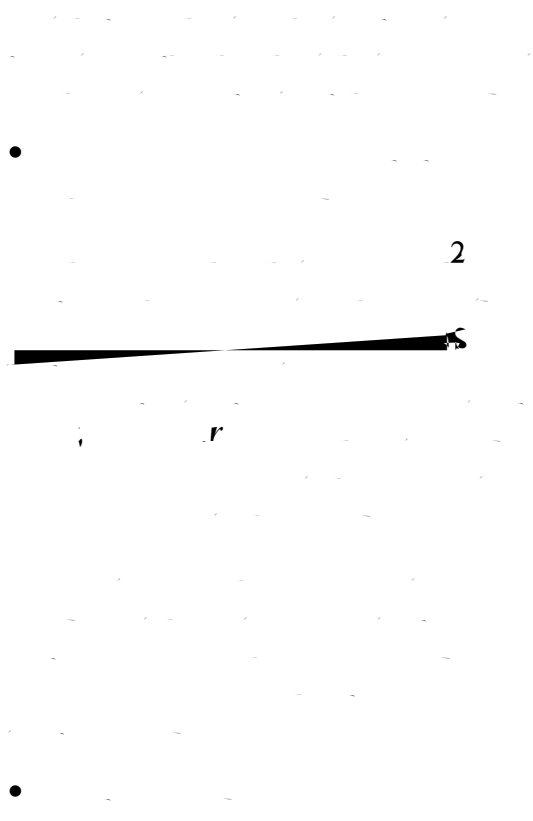

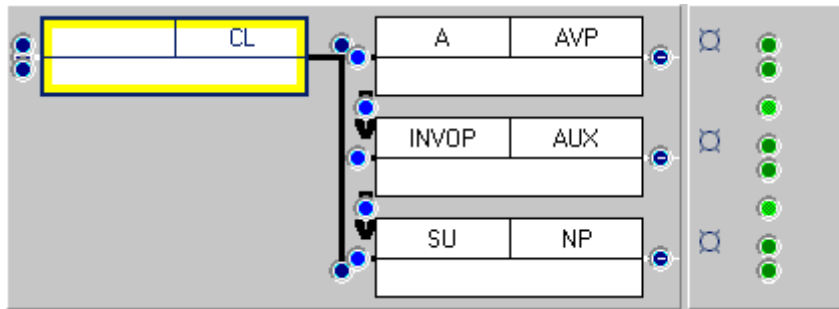

8.

1. 2. 24. 9.

•





.....



.....



Q

X

Y =

4

- 
- 

[Redacted line]

9



- 

< 2 >

44

v

d

d

[Redacted line]

-











52 v

dL

Y



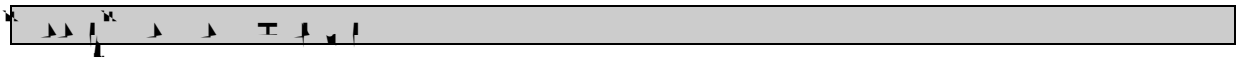

6 dv d



6

4 d L S

q q q q Y Y





6 ▸ L

1.  $\frac{1}{2} \times \frac{1}{3} = \frac{1}{6}$       2.  $\frac{1}{4} \times \frac{1}{5} = \frac{1}{20}$       3.  $\frac{1}{6} \times \frac{1}{7} = \frac{1}{42}$       4.  $\frac{1}{8} \times \frac{1}{9} = \frac{1}{72}$

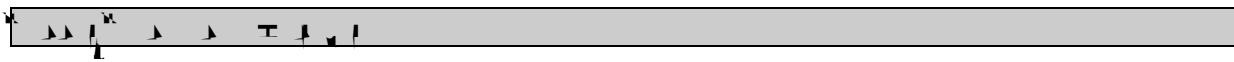

- 
- \*
- 
- 
- 

4

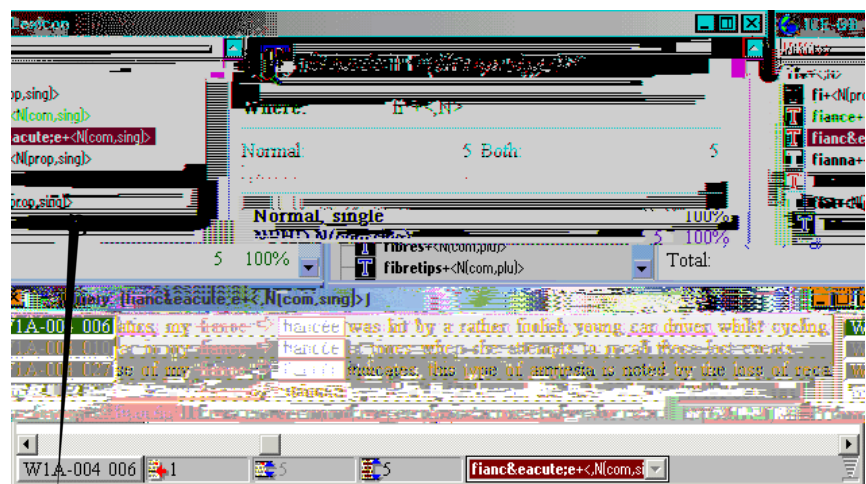
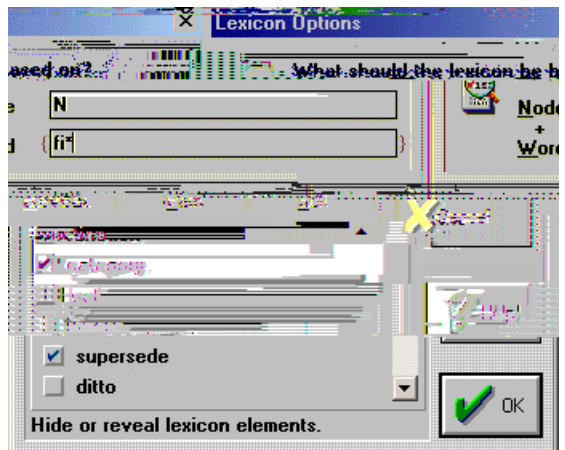

64



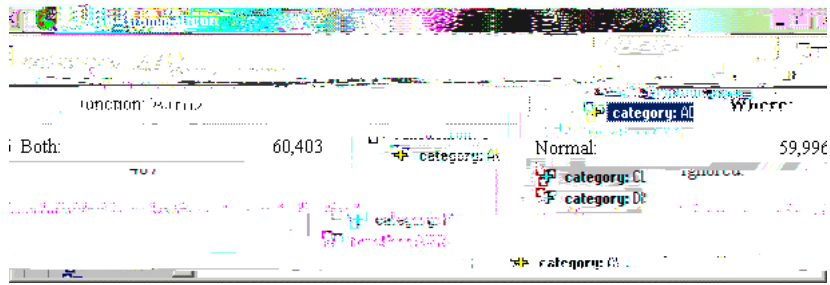

Y  
Y

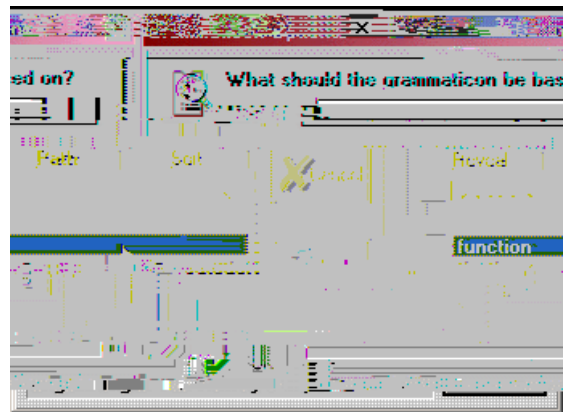

2

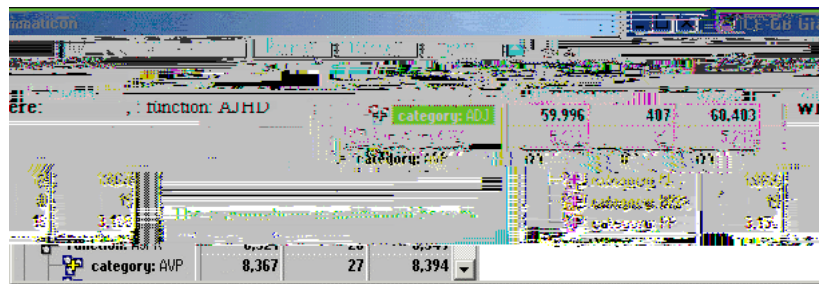



7

Introduction to ICECUP III

•

5

